

Data Sheet



Article number: 58MI16S0060CAP

Description: Cylinder MI-16x60-S-CA, Ø16x60
Double acting type - port M5

Measures

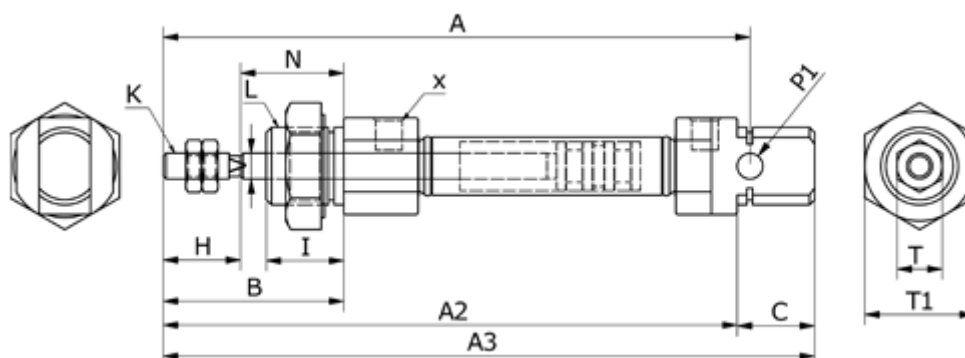

A	= 98	K	= M6x1,0	V = 6
A2	= 56	L	= M16x1,5	X = M5x0,8
A3	= 111	N	= 22	
B	= 38	O	= 13	
Bore diameter	= 16	P1	= 6	
C	= 17	Stroke	= 60	
HS	= 16	T	= 10	
I	= 17	T1	= 22	